

MAGMA CC 6.0

Autonomous Engineering

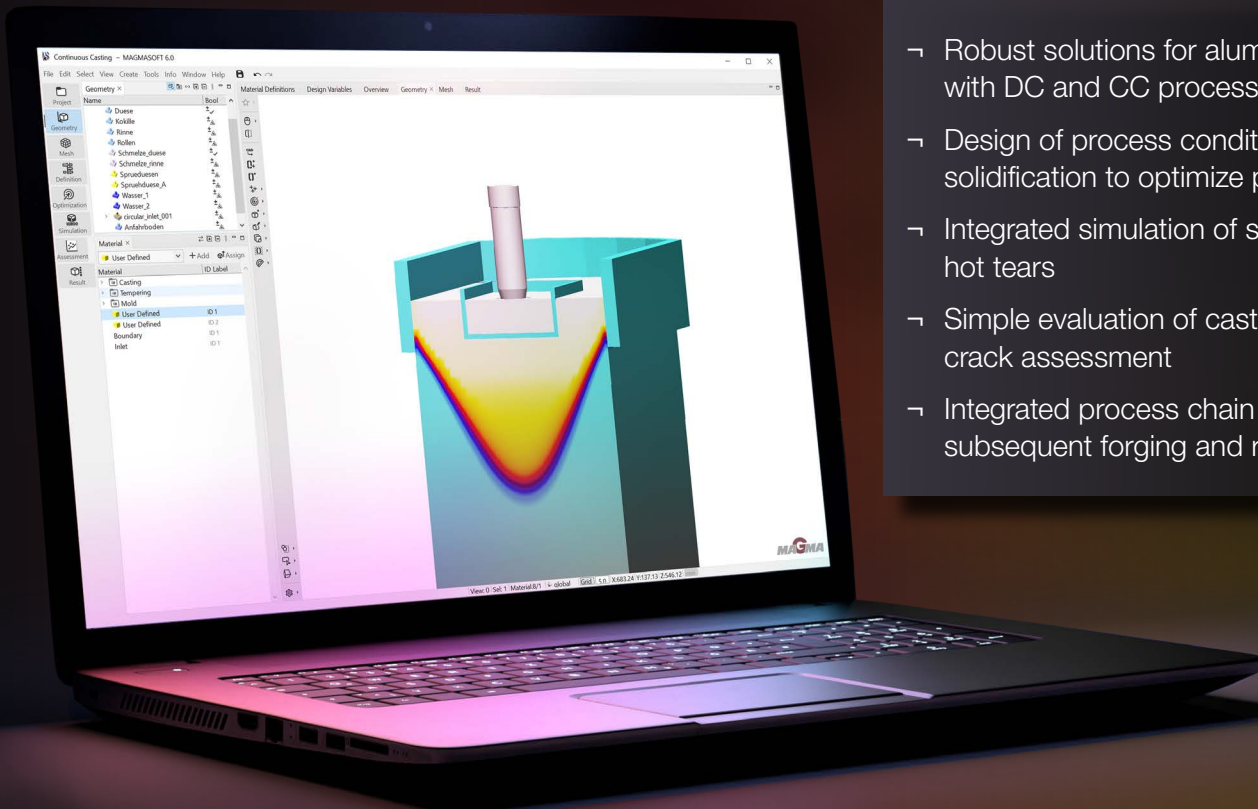

Direct Chill and Continuous Casting of Aluminum Alloys



- Robust solutions for aluminum production with DC and CC processes
- Design of process conditions for flow and solidification to optimize product quality
- Integrated simulation of stress, cracks and hot tears
- Simple evaluation of casting stresses and crack assessment
- Integrated process chain for casting with subsequent forging and rolling processes

Robust, Economical, Fast, **Optimized**

Optimize all aspects of continuous casting processes and find the best solution for your requirements – with MAGMASOFT® autonomous engineering and MAGMA CC.

MAGMASOFT® and the dedicated turn-key solution MAGMA CC are comprehensive and powerful simulation tools for all aspects around designing and improving of product quality. The focus is on establishing robust continuous casting processes while ensuring optimal profitability by saving resources, time and costs.

With both MAGMASOFT® and MAGMA CC, you use simulations in an automated virtual design of experiments or genetic optimization. The result is Autonomous Engineering – systematic and fully automated decision-making for reliable product quality and optimal operating points.

With Autonomous Engineering, you can simultaneously pursue different quality and cost objectives. From securing product quality and process robustness at the concept stage, through continuous improvement of profitability during production.

MAGMASOFT® and MAGMA CC autonomous engineering:

- Support you in the comprehensive prediction of all process steps in continuous casting.
- Offer you a virtual test environment for optimizing productivity.
- Enable you to make quick decisions and save time for all parties involved.
- Allow proactive quality management by understanding process fluctuations.
- Improve communication and cooperation within your organization and with customers.



Targeted and Systematic Success

The MAGMA APPROACH, which is fully integrated in MAGMASOFT® and MAGMA CC, is a systematic methodology for achieving your objectives using virtual experiments. In combination with MAGMASOFT® autonomous engineering, secured actions can be identified and implemented to achieve continuous improvements, without economic risks.

The MAGMA APPROACH supports you at every stage of the product development or improvement process, through a systematic methodology. The result is a robust process that is optimally designed for the desired objectives and prevents casting defects.

Set Your Objectives, Define Your Variables, Specify Your Criteria

MAGMA CC is the fully integrated solution for the virtual design and optimization of direct chill and continuous casting processes for aluminum alloys. MAGMA CC offers parametric geometry modeling, automatic meshing, an extensive database and comprehensive tools for evaluation and statistical assessment of results.

MAGMA CC considers the flow, heat transfer, solidification and development of stresses in the inflowing metal, the solidi-

fying strand and the mold. The software is capable of simulating vertical and horizontal casting processes for any product shape.

MAGMA CC supports you in process design through integrated capabilities for virtual designs of experiments. This allows identifying robust process windows or autonomously optimizing operating points, guaranteeing high product quality with process stability.

Continuous Casting Process	ID	Continuous Casting
Continuous Casting - Vertical Aluminum AlMg1Si_6061 Weight: 366.37 kg Total Weight: 469.04 kg Yield: 78.11 %		
> Cast Alloy		
> Permanent Mold		
> Tempering Channel		
> Starting Ingot		
> User Defined		

Withdrawal Definition
Specify parameters for withdrawal process. Select one of the available control types.

Control Type:
 Casting Speed
 Hub

Casting Speed

Time (s)	Casting Speed (mm/min)
0.0	0.0
100.0	50.0
1000.0	100.0
10000.0	200.0
20000.0	2000.0

Starting ingot height [h] mm

OK Cancel

Comprehensive description of the continuous casting process and definition of the casting speed

Preparation

In addition to casting speed and casting temperature of the liquid metal, the cooling conditions in the mold (primary cooling) and in the secondary cooling zones are decisive process variables for the design of the continuous casting process.

The realistic representation of the entire process allows the assessment of the flow conditions during start-up and subsequent strand withdrawal. Optionally, the flow conditions in the launder can also be taken into account.

Velocity distribution in the stationary state

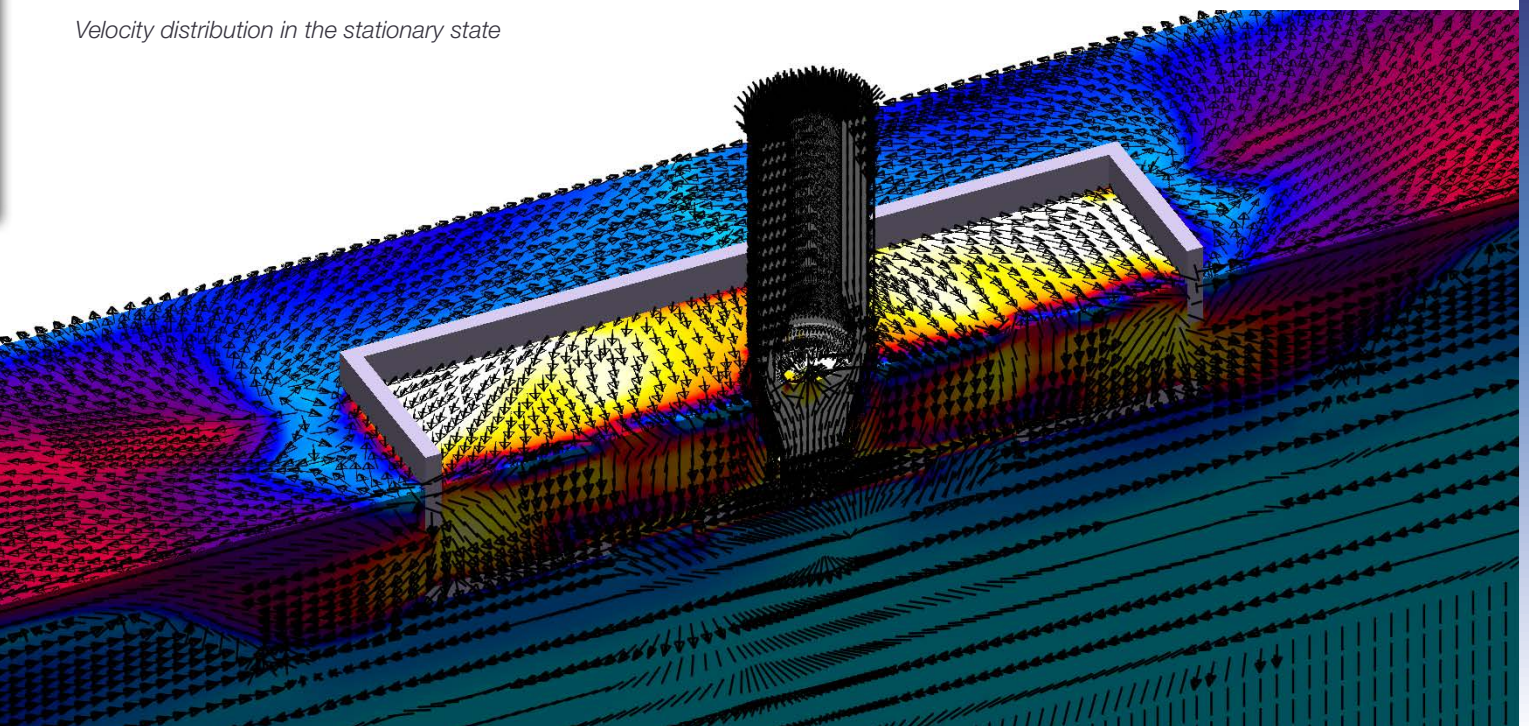

Shroud and Submerged Entry Nozzle Layout

In MAGMA CC, you can fully consider the start-up process, from the filling of the mold with liquid metal to the start of strand withdrawal:

- During start-up, the nozzle can be optimized for the flow.
- The starting point for the subsequent simulation of strand withdrawal are the temperatures and flow during start-up.
- The flow and heat balance in mold and launder can be analyzed separately or coupled with the casting process.
- An optimized launder design helps to achieve a high level of metal purity.

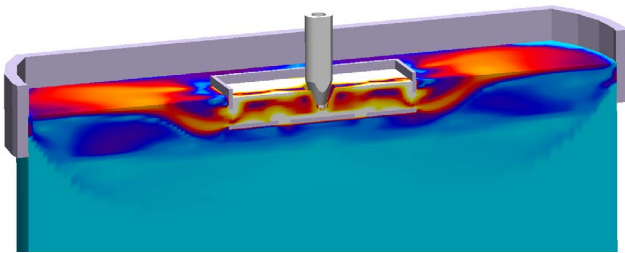

Flow behavior during start-up of aluminum DC casting

Forced and Natural Convection

MAGMA CC allows the combined consideration of forced and natural convection in the liquid metal and in the mushy zone. Both the inflow and the temperature gradients in the metal are taken into account.

Prediction of Inclusions

MAGMA CC considers the flow-related transport of particles with a predefined size and density in the liquid metal. This allows the evaluation of inclusions in the flow during start-up and reoxidation inclusions due to convection during solidification.

- Calculation of formation, growth, transport and agglomeration of inclusions, taking into account the potential for oxidation in both the launder and the mold during casting

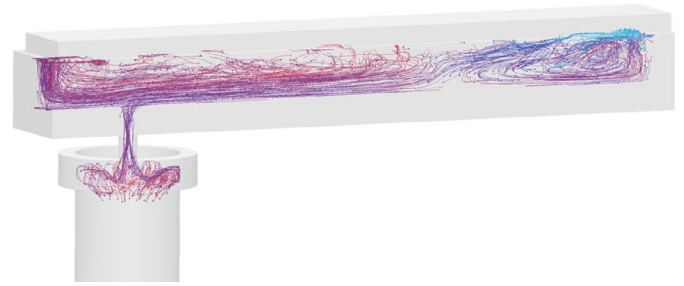

Tracer particles visualize the flow in the launder.

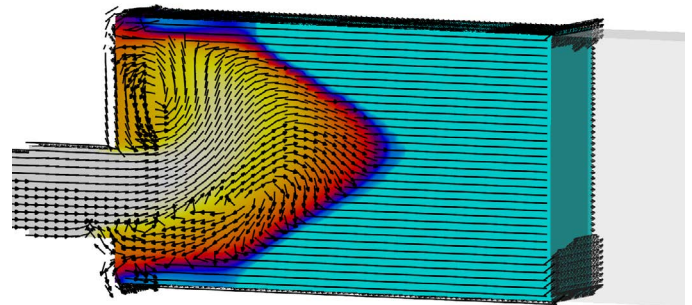

Velocities during start-up for horizontal CC processes

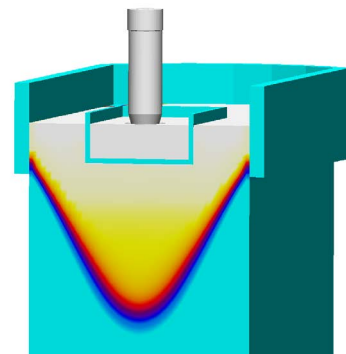

Temperatures during start-up showing the solidified shell profile

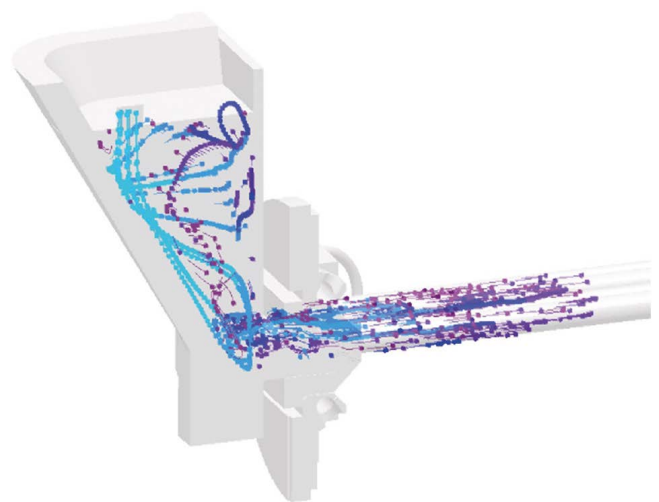

Particle movement for a horizontal continuous casting process

Primary Cooling

The thermal conditions in the mold are decisive for the solidification and cooling of the strand. MAGMA CC allows:

- Setting of process-specific parameters, such as water flow rates in cooling channels, flux and graphite inserts in the mold or for the secondary cooling
- Prediction of temperatures in the strand and mold with quantitative evaluation of the thermal balance for the entire process

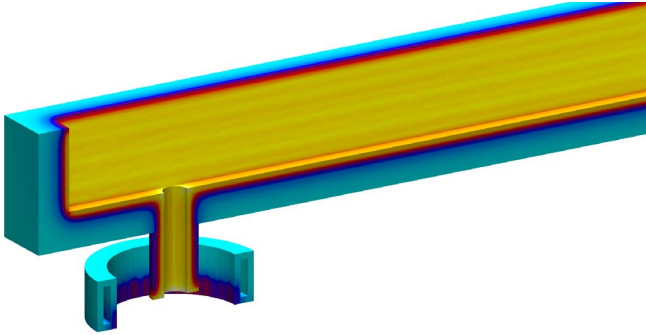

Temperature in mold and launder

Secondary Cooling

The secondary cooling can be defined for various cooling zones using recommended heat transfer coefficients from the database. Currently, the program supports three different types of heat transfer coefficients:

- Radiation and/or convection
- Spray cooling
- Film cooling after spraying

Stationary Temperature Distribution

MAGMA CC determines the stationary temperature distribution in the strand and the mold, and evaluates the importance of the influencing parameters through statistical design of experiments and autonomous optimization.

- Determination of the influence of process variables on the heat balance, contact conditions between strand and mold, metal flow, primary and secondary cooling, withdrawal speed as a function of time
- Accurate prediction of the sump profile
- Evaluation of optimal process parameters for improving the energy efficiency of the process

Stress Distribution in the Strand

The temperature distribution and residual stresses of the metal in the mold are decisively influenced by the contact and heat transfer between the strand and the mold surface.

MAGMA CC supports an accurate process design through:

- Coupled simulation of temperatures and stresses in the strand and mold
- Consideration of the air gap between the strand and mold including reduced heat transfer due to thermal contraction
- Support of mold design, e.g., through optimization of the conicity
- Layout of the primary and secondary cooling, ensuring the required cooling of the strand to avoid defects such as cracking

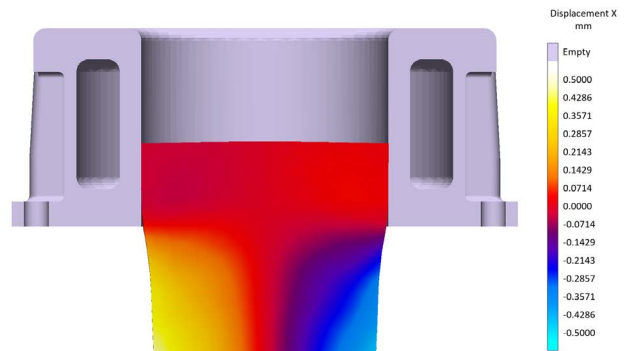

Consideration of shrinkage and gap formation

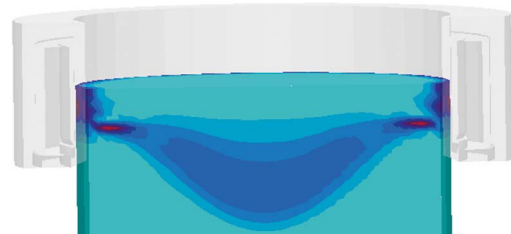

Hot tear tendency in the strand

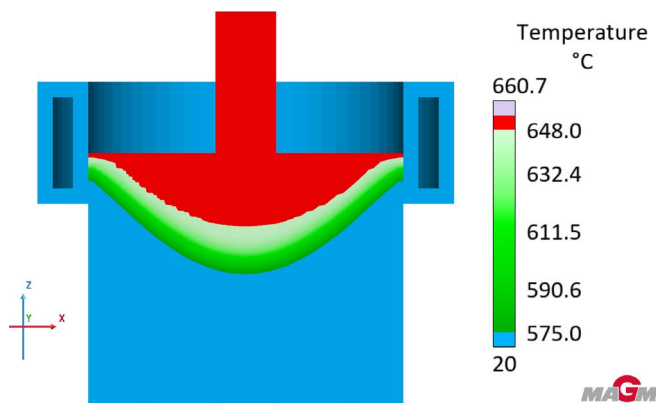

Fraction liquid as information during the entire process

Improved Solidification

- Calculation of the solidification front to avoid bleedout and bleedover
- Evaluation of thermal gradient and cooling rate

Heat Balance

In MAGMA CC, the efficiency of the mold can be used, e.g., as a quality criterion for a stable casting process. The efficiency is calculated as the ratio of the total heat output.

Secure Processes With Designs of Experiments

In MAGMA CC, you can freely and systematically vary your process parameters to quantify the influence of different production conditions on quality and productivity.

Robust Processes

Determine the influence of process fluctuations on the solidification behavior of your product through systematic virtual experimentation. MAGMA CC autonomous engineering quantitatively identifies main effects and correlations, and determines concrete actions to control your production.

- High productivity (maximum casting speed)
- Cost and energy efficiency
- Reduction of porosity and shrinkage
- Reducing the risk for bleedout
- Reduction of residual stresses and cracking tendency
- Design optimization of launder and nozzle

Energy IN

Energy OUT

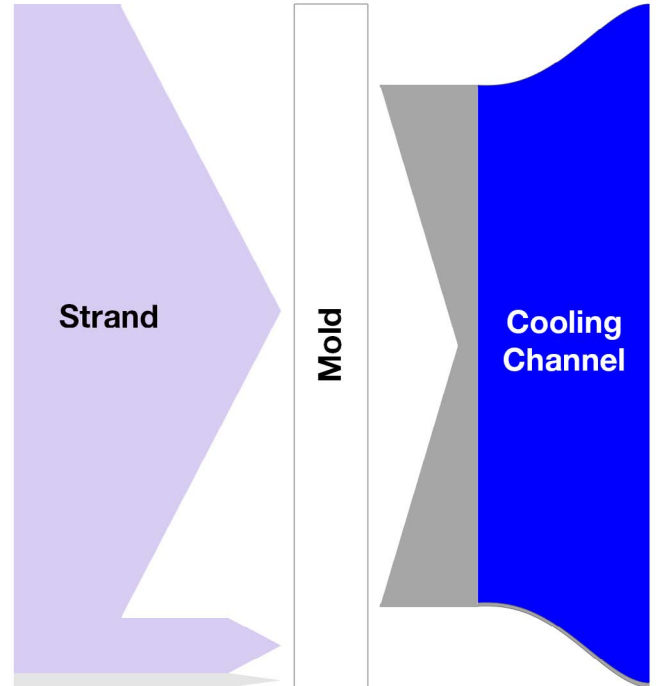

Sankey chart showing the heat balance in the mold

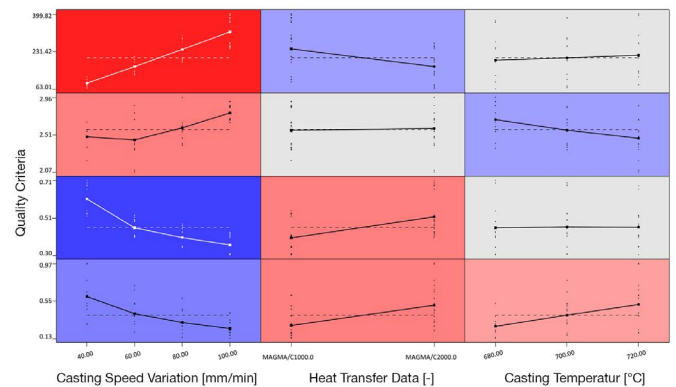

Main effect matrix showing the influence of different process parameters on the product quality

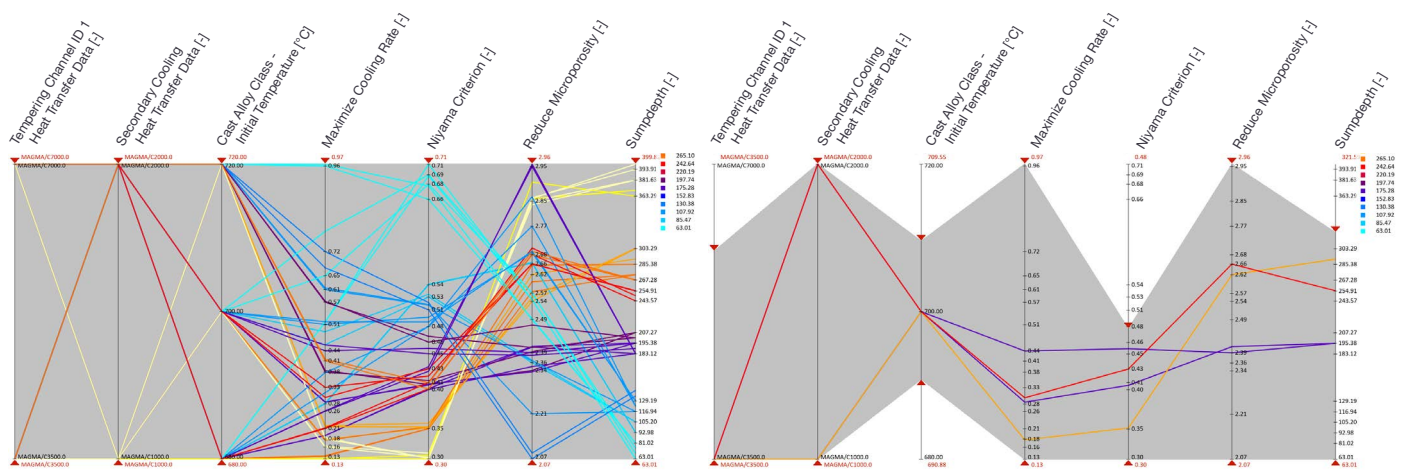

Parallel coordinate diagrams with process parameters and objectives

Work **Efficiently** and **Systematically**

Your time is limited! To achieve your goals, it is crucial to systematically and efficiently utilize all the available possibilities in MAGMASOFT®'s comprehensive toolbox.



Intuitive Process Control

Use the control of all relevant process steps to optimize continuous casting processes. Beginning with the metal flow in the launder and nozzle and into the mold to describe the start-up process, to the withdrawal and continuous operation including consideration of the secondary cooling.

Continuous Casting Process

Specify parameters for filling and withdrawal process control.

Continuous Casting Process Control

- No Flow
- Consider Flow with Prefilled Launder
- Consider Flow with Filling of Launder

Start Withdrawal

Directly with simulation of process

Stop Withdrawal

- Strand material filled
- After start of withdrawal s
- Strand length mm



Act & Check Your **Improvements**

Success is more than software and hardware. MAGMA's professional team is ready to comprehensively support you in realizing your goals. You can take advantage of the services of our MAGMAacademy, engineering and support teams when and how it suits you, and all from a single source.



Implementation

All MAGMASOFT® programs are more than just software. They offer a methodology for optimizing engineering, communication and profitability in your organization.

Even before starting with our software, we will take the time to discuss with you the most important factors to ensure an effective and secured use of our tools based on your situation: from the required computer hardware through the qualification and training of users, to jointly defining objectives regarding where you want to be in the next year.

Whether you are a new customer or a long-time user of our software: We have plans with you!

MAGMASupport

MAGMASupport stands for the competent, methodical and fast support of our customers worldwide regarding all questions in the application of and problem-solving with our products. With the MAGMA APPROACH, our qualified support staff will help you to make better use of our software every day.

MAGMAacademy

The MAGMAacademy systematically supports you in the implementation of both casting process and virtual optimization, from the initial rollout to the comprehensive application of Autonomous Engineering throughout the entire organization.

In our training courses, workshops and seminars, we convey interdisciplinary understanding across all processes and departments for the best possible use of MAGMASOFT® – conducted at our offices or through a customized solution on-site.

MAGMAengineering

As an independent and competent partner, MAGMAengineering supports a successful virtual product development, tooling design and optimization of your robust foundry processes within the framework of engineering projects.

An interdisciplinary and international team of experts, with numerous years of casting expertise, is available to work with you using MAGMASOFT® autonomous engineering to address your challenges.

Casting Knowledge. In a Software.

MAGMASOFT® 6.0



MAGMASOFT®
autonomous engineering



More Information:

